

Aplikace matematiky

Vladimír Janovský; Petr Procházka
Contact problem of two elastic bodies. II

Aplikace matematiky, Vol. 25 (1980), No. 2, 110–136

Persistent URL: <http://dml.cz/dmlcz/103844>

Terms of use:

© Institute of Mathematics AS CR, 1980

Institute of Mathematics of the Czech Academy of Sciences provides access to digitized documents strictly for personal use. Each copy of any part of this document must contain these *Terms of use*.



This document has been digitized, optimized for electronic delivery and stamped with digital signature within the project *DML-CZ: The Czech Digital Mathematics Library* <http://dml.cz>

CONTACT PROBLEM OF TWO ELASTIC BODIES – Part II

VLADIMÍR JANOVSKÝ, PETR PROCHÁZKA

(Received September 1, 1977)

INTRODUCTION

A special class of contact problems was formulated in Part I of this paper, see [4]. One discrete version was also proposed and its numerical solution by means of p , A-Algorithm was discussed. Convergence of the algorithm to the “discrete” solution was proved.

The aim of Part I has been the analysis concerning the convergence of the “discrete” solution to the solution of the “continuous” problem. Part II is divided into the following chapters:

4. Convergence
 5. Smooth approximation of K
 6. Approximation properties of the spaces $V^{(p)}$
- Appendix.

Chapter 4 answers the question of convergence under certain assumptions. These assumptions are discussed in Chapters 5 and 6. In Appendix one remark to [6], Theorem 7.2 on page 112 is made.

4. CONVERGENCE

In this chapter we investigate convergence of the solution $u^{(p)}$ of Problem (2.1) to the solution u of Problem (1.2).

4.1. Assumptions

We shall start with a definition of the linear interpolation along Γ .

Definition 4.1. Let p be an integer and let the partition $\tau^{(p)} \equiv \{\tau_{i,p}\}_{i=1}^{k(p)}$ of Γ be that given in Definition 2.2. Also, let w be a real function of Γ and $X \in \Gamma$ (i.e. assume

that there exists $\tau_{i,p} \in \tau^{(p)}$ such that $X \in \tau_{i,p}$; see Fig. 3). Then the value $(L^{(p)}w)(X)$ of the function $L^{(p)}w$ at the point X is defined as follows:

$$(L^{(p)}w)(X) = (tw(N_{i,p}) + (\text{meas } \tau_{i,p} - t)w(N_{i-1,p}))(\text{meas } \tau_{i,p})^{-1},$$

where $\{N_{i,p}\}$ is given in Definition 2.2, and t is the Lebesgue measure of the

$$\overbrace{\text{arc } N_{i-1,p}, X} \text{ i.e. } t \equiv \int_{(N_{i-1,p}, X)} d\sigma;$$

see Fig. 3.

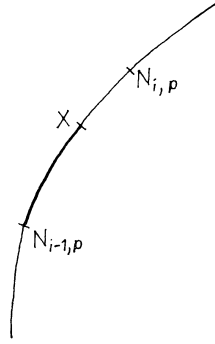

Fig. 3.

Remark 4.1. It can be shown that

$$I^{(p)}(L^{(p)}w) = \int_{\Gamma} (L^{(p)}w) d\sigma.$$

We introduce the following assumptions:

- (A) For any $w \in K$ there exists a sequence $\{w_\varepsilon\}_{\varepsilon \in (0,1)}$ such that $w_\varepsilon = [w_{1,\varepsilon}, w_{2,\varepsilon}] \in K$, $w'_{i,\varepsilon} \in E(\Omega')$, $w''_{i,\varepsilon} \in E(\Omega'')$ for $i = 1, 2$
and
 $w_\varepsilon \rightarrow w$ in V for $\varepsilon \rightarrow 0_+$.

The symbol $E(G)$ denotes the space of all infinitely differentiable functions on a domain G which can be continuously extended to the closure \bar{G} of G .

- (A1) If $w \in V$, $w = [w_1, w_2]$, $w'_i \in E(\Omega')$, $w''_i \in E(\Omega'')$ for $i = 1, 2$ then there exists a sequence $\{w^{(p)}\}_{p=1}^\infty$ such that $w^{(p)} \in V^{(p)}$, $w^{(p)} \rightarrow w$ in V for $p \rightarrow +\infty$, $[w^{(p)}]_v = [w]_v$ on $N^{(p)}$ for each p .
(A2) Let $\{w^{(p)}\}$ be a sequence of $w^{(p)} \in V^{(p)}$. Then there exists a constant C such that $\|[w^{(p)}]_v - L^{(p)}[w^{(p)}]_v\|_{L_2(\Gamma)} \leq Cp^{-1/2} \|w^{(p)}\|$ for each integer p .

Remark 4.2. The meaning of the assumptions made in this chapter will be discussed in detail in Chapters 5 and 6. Assumption (A) will be justified under certain conditions concerning smoothness of both boundaries $\partial\Omega'$ and $\partial\Omega''$ (see Chapter 5). Assumptions (A1) and (A2) will be justified provided that the asymptotic behaviour (as $p \rightarrow +\infty$) of the partitions $\Omega^{(p)}$ has the usual characteristics. In assumption (A2) the parameter p^{-1} plays the role of the asymptotic “mesh” size estimate.

4.2. Convergence of displacements

We consider a sequence $\{u^{(p)}\}_{p=1}^{\infty}$, where $u^{(p)}$ solves Problem (2.1) for a given integer p .

Let T_1 and T_2 be the splitting operators from Definition 1.4. (Recall the role of $\Gamma^0 \subset \Gamma$ in the definition of T_2 .)

Lemma 4.1. *If $\Gamma_0 \subset \Gamma$ is chosen in such a way that either $q_0 > 0$ or $q_0 < 0$ then there exists a constant C such that either*

$$(T_2 u^{(p)})_2'' \leq Cp^{-1/2} \|T_1 u^{(p)}\|$$

or

$$-(T_2 u^{(p)})_2'' \leq Cp^{-1/2} \|T_1 u^{(p)}\|$$

for any integer p .

Proof. Consider the case $q_0 > 0$ (the proof for the case $q_0 < 0$ is the same). Since $[u^{(p)}]_v \leq 0$ on $N^{(p)}$, it is $L^{(p)}[u^{(p)}]_v \leq 0$ on Γ (linear interpolation of nonpositive values on $N^{(p)}$), i.e.

$$q_0 \int_{\Gamma_0} L^{(p)}[u^{(p)}]_v \, d\sigma \leq 0.$$

Hence

$$\begin{aligned} (T_2 u^{(p)})_2'' &\leq q_0 \int_{\Gamma_0} [u^{(p)}]_v \, d\sigma - q_0 \int_{\Gamma_0} L^{(p)}[u^{(p)}]_v \, d\sigma \leq \\ &\leq q_0 (\text{meas } \Gamma_0)^{1/2} \|[u^{(p)}]_v - L^{(p)}[u^{(p)}]_v\|_{L_2(\Gamma)}. \end{aligned}$$

In accordance with the assumption (A2) we can estimate

$$(T_2 u^{(p)})_2'' \leq C_0 p^{-1/2} \|u^{(p)}\|.$$

However, it is evidently

$$\|u^{(p)}\| \leq C_1 (\|T_1 u^{(p)}\| + \|T_2 u^{(p)}\|) = C_1 (\|T_1 u^{(p)}\| + C_3 |(T_2 u^{(p)})_2''|).$$

Hence, combining the two inequalities, we easily derive that

$$(T_2 u^{(p)})_2'' [1 - C_4 p^{-1/2} \cdot \text{sgn} (T_2 u^{(p)})_2''] \leq C_1 p^{-1/2} \|T_1 u^{(p)}\|,$$

i.e.

$$(T_2 u^{(p)})_2'' \leq Cp^{-1/2} \|T_1 u^{(p)}\|.$$

Lemma 4.2. *If $\|u^{(p)}\| \rightarrow +\infty$ then $J(u^{(p)}) \rightarrow +\infty$ for $p \rightarrow +\infty$.*

Proof. First we realise that

$$J(u^{(p)}) = A(T_1 u^{(p)}, T_1 u^{(p)}) - \sum_{i=1}^2 \int_{\Omega} F_i \cdot (T_1 u^{(p)})_i \, dx_1 \, dx_2 - \\ - \sum_{i=1}^2 \int_{\Gamma_1} P_i \cdot (T_1 u^{(p)})_i \, d\sigma - \int_{\Omega''} F_2'' \cdot (T_2 u^{(p)})_2'' \, dx_1 \, dx_2.$$

According to Lemma 1.2, we estimate

$$(4.1) \quad J(u^{(p)}) \geq C \|T_1 u^{(p)}\|^2 - C_2 \|T_1 u^{(p)}\| - (T_2 u^{(p)})_2'' \int_{\Omega''} F_2'' \, dx_1 \, dx_2.$$

We assume that

$$\int_{\Omega''} F_2'' \, dx_1 \, dx_2 > 0$$

(the case “<” can be investigated in the same way; the case “=” is excluded, see (2.2)). In the definition of T_1 , T_2 we choose Γ_0 such that $q_0 > 0$; see Definition 1.4. Hence, according to (4.1) and Lemma 4.1, we can estimate

$$(4.2) \quad J(u^{(p)}) \geq C \|T_1 u^{(p)}\|^2 - C_2 \|T_1 u^{(p)}\| - C_1 p^{-1/2} \|T_1 u^{(p)}\|.$$

If $\|u^{(p)}\| \rightarrow +\infty$ then either

$$(i) \quad \|T_1 u^{(p)}\| \rightarrow +\infty$$

or

$$(ii) \quad \|T_2 u^{(p)}\| \rightarrow +\infty \text{ and the sequence } \{\|T_1 u^{(p)}\|\}_{p=1}^{\infty} \text{ is bounded.}$$

In the case (i) we have $J(u^{(p)}) \rightarrow +\infty$ immediately as a consequence of (4.2). In the case (ii) we easily derive that $|(T_2 u^{(p)})_2''| \rightarrow +\infty$. Taking into account Lemma 4.1 (with $q_0 > 0$), we conclude that

$$(T_2 u^{(p)})_2'' \int_{\Omega''} F_2'' \, dx_1 \, dx_2 \rightarrow -\infty.$$

Hence, in accordance with (4.1), we obtain $J(u^{(p)}) \rightarrow +\infty$.

Theorem 4.1. *The sequence $\{u^{(p)}\}$ is bounded in the space V .*

Proof is easy consequence of Lemma 4.2 and the fact that $J(u^{(p)}) \leq 0$ for any integer p (see (2.1) for $w \equiv 0$).

Theorem 4.2. *There exists $u \in V$ and a subsequence $\{u^{(p)}\}_{p \in M}$, where $M \subset \{1, 2, \dots\}$, such that*

$$u^{(p)} \rightarrow u \quad (\text{weakly}) \text{ in } V \\ [u^{(p)}]_v \rightarrow [u]_v \text{ in } L_2(\Gamma) \quad \forall p \in M, p \rightarrow +\infty.$$

Proof. With respect to Theorem 4.1, the sequence $\{u^{(p)}\}_{p=1}^\infty$ is compact in the weak topology of the space V . Hence, the first assertion of Theorem 4.2 holds immediately. Moreover,

$$[u^{(p)}]_v \rightarrow [u]_v \quad (\text{weakly}) \text{ in } L_2(\Gamma).$$

It is well known (e.g. [6], Theorem 6.2, page 107) that the restriction of the spaces $W^{1,2}(\Omega')$ and $W^{1,2}(\Omega'')$ into $L_2(\Gamma)$ is compact. Hence, the convergence assertion above is also valid in the strong sense.

Lemma 4.3. *If $\{u^{(p)}\}_{p \in M}$ and u are respectively the subsequence and the function of V from Theorem 4.2, then*

$$J(u) \leq J(w) \quad \forall w \in K.$$

Proof. Let w be an element of K . With respect to the assumptions (A) and (A1), there exist sequences $\{w_\varepsilon\}_{\varepsilon \in (0,1)}$, $\{w_\varepsilon^{(p)}\}_{p=1}^\infty$ ($\forall \varepsilon \in (0,1)$) such that

$$\begin{aligned} w_\varepsilon \in K, \quad (w_\varepsilon)'_i \in E(\Omega'), \quad (w_\varepsilon)''_i \in E(\Omega''), \quad i = 1, 2 \\ w_\varepsilon^{(p)} \in V^{(p)}, \quad [w_\varepsilon^{(p)}]_v \leq 0 \text{ on } N^{(p)} \\ \lim_{\varepsilon \rightarrow 0+} w_\varepsilon = w \text{ in } V \\ \lim_{p \rightarrow +\infty} w_\varepsilon^{(p)} = w_\varepsilon \text{ in } V. \end{aligned}$$

As $u^{(p)}$ solves Problem (2.1), we have

$$J(u^{(p)}) \leq J(w_\varepsilon^{(p)}) \quad \forall \varepsilon \in (0,1), \quad \forall \text{ integer } p.$$

The functional $J(\cdot)$ is Fréchet-differentiable and convex; hence it is weakly lower semi-continuous, which means:

If $u^{(p)} \rightarrow u$ (weakly) in V then

$$\liminf_{p \rightarrow +\infty} J(u^{(p)}) \geq J(u).$$

The weak convergence of $\{u^{(p)}\}_{p \in M}$ is guaranteed by Theorem 4.2. Using both inequalities above, we can derive

$$(4.3) \quad J(u) \leq \liminf_{\substack{p \rightarrow +\infty \\ p \in M}} J(u^{(p)}) \leq \limsup_{\substack{p \rightarrow +\infty \\ p \in M}} J(u^{(p)}) \leq J(w) \quad \forall w \in K.$$

Lemma 4.4. *If $\{u^{(p)}\}_{p \in M}$ and u are respectively the subsequence and the function from Theorem 4.2, then*

$$u \in K.$$

Proof. Since $u^{(p)}$ is a solution to Problem (2.1), it is $[u^{(p)}]_v \leq 0$ on $N^{(p)}$, i.e. $L^{(p)}[u^{(p)}]_v \leq 0$ on Γ . Using Theorems 4.2 and 4.1 and assumption (A2), we easily prove that

$$L^{(p)}[u^{(p)}]_v \rightarrow [u]_v \text{ in } L_2(\Gamma).$$

It means that $L^{(p)}[u^{(p)}]_v$ converges to $[u]_v$ a.e. on Γ and this implies that $[u]_v \leq 0$ a. e. on Γ .

Theorem 4.3. *The whole sequence $\{u^{(p)}\}_{p=1}^\infty$ converges to u in V , i.e.*

$$u^{(p)} \rightarrow u \text{ in } V \text{ for } p \rightarrow +\infty .$$

Proof. We now show that *the whole* sequence $\{u^{(p)}\}_{p=1}^\infty$ weakly converges. Let us suppose the contrary:

According to Theorem 4.1 it means that there exist two subsequences $\{u^{(p)}\}_{p \in M}$, $\{u^{(p)}\}_{p \in M'}$ such that

$$u^{(p)} \rightarrow u \in V \quad \text{for } p \in M, p \rightarrow +\infty$$

$$u^{(p)} \rightarrow u' \in V \quad \text{for } p \in M', p \rightarrow +\infty$$

and

$$u \neq u' .$$

Lemmas 4.3 and 4.4 imply that both functions u and u' are solutions to Problem (1.2). This contradicts Theorem 1.1.

Hence, as a consequence of Theorem 4.2, there exists $u \in V$ such that

$$(4.4) \quad \begin{aligned} u^{(p)} &\rightarrow u && \text{(weakly) in } V \\ [u^{(p)}] &\rightarrow [u]_v && \text{in } L_2(\Gamma) . \end{aligned}$$

We now proceed to the proof of strong convergence of the sequence $\{u^{(p)}\}_{p=1}^\infty$. Substituting $w = u$ into (4.3), we derive that

$$(4.5) \quad J(u^{(p)}) \rightarrow J(u) \quad \text{for } p \rightarrow +\infty .$$

We recall the following identity:

$$\begin{aligned} J(u) - J(u^{(p)}) &= A(u - u^{(p)}, u) - \frac{1}{2}A(u - u^{(p)}, u - u^{(p)}) - \\ &- \int_{\Omega} F \cdot (u - u^{(p)}) \, dx_1 \, dx_2 - \int_{\Gamma_1} P \cdot (u - u^{(p)}) \, d\sigma . \end{aligned}$$

Hence, taking into account the weak convergence (4.4) and the assertion (4.5), we prove that

$$A(u - u^{(p)}, u - u^{(p)}) \rightarrow 0 \quad \text{for } p \rightarrow +\infty ,$$

i.e.

$$A(T_1(u - u^{(p)}), T_1(u - u^{(p)})) \rightarrow 0 \quad \text{for } p \rightarrow +\infty .$$

Finally, Lemma 1.2 implies that

$$(4.6) \quad C_1 \|T_1(u - u^{(p)})\|^2 \leq A(T_1(u - u^{(p)}), T_1(u - u^{(p)})) \rightarrow 0 \quad \text{for } p \rightarrow +\infty .$$

Let us notice that

$$\|u - u^{(p)}\|^2 \leq C_0 \|T_1(u - u^{(p)})\|^2 + C_0 \|T_2(u - u^{(p)})\|^2 .$$

The first term on the right-hand side converges to zero with respect to (4.6). The second also converges to zero as a consequence of (4.4) and the definition of T_2 (see Definition 1.4).

4.3. Convergence of reactive forces

Unfortunately we have not been able to establish the convergence of $\{\lambda^{(p)}\}_{p=1}^{\infty}$. For this reason in this section we only point out the difficulties which we have encountered in attempting a proof of convergence. We shall start with the saddle formulation of our main Problem (1.2), i.e. we involve Lagrange multipliers. We set

$$A \equiv \{\mu; \mu \in W^{-1/2,2}(\Gamma), \mu \geq 0 \text{ on } \Gamma \text{ in the natural functional sense}\}.$$

Problem. Find $u \in V$ and $\lambda \in A$ such that

$$J(u) + \int_{\Gamma} \mu[u]_{\nu} d\sigma \leq J(u) + \int_{\Gamma} \lambda[u]_{\nu} d\sigma \leq J(w) + \int_{\Gamma} \mu[w]_{\nu} d\sigma \quad \forall \mu \in A, \quad \forall w \in V.$$

It is possible to show that there exists a unique solution to the above problem using the same technique as we applied to Problem (2.3)–(2.4). Moreover, the function u solves our main Problem (1.2) and the function λ can be interpreted as the reaction force of the body Ω'' along Γ .

Problem (2.3)–(2.4) is actually a discrete version of the above problem (spaces V and A are replaced by $V^{(p)}$ and $A^{(p)}$). Hence, it is expected that $u^{(p)} \rightarrow u$ and $\lambda^{(p)} \rightarrow \lambda$ in the corresponding spaces; the symbols $u^{(p)}$, $\lambda^{(p)}$ denote the solution of Problem (2.3)–(2.4). The former assertion is true; see the previous section 4.2. To prove the latter, it is necessary (and sufficient) to show that the sequence $\{u^{(p)}\}_{p=1}^{\infty}$ is bounded in some norm connected with the norm of the space $W^{-1/2,2}(\Gamma)$. This is the main difficulty which we have not been able to overcome.

4.4. Convergence of “bolted” displacements

We now consider the meaning of the auxiliary Problem (3.2)–(3.3). The solution to this problem represents an intermediate step for obtaining the solution of Problem (2.1); see Conclusion of Chapter 3. In this section we show that the auxiliary problem also approximates the main Problem (2.1).

Theorem 4.4. *Let a point $A \in \Gamma$ be fixed and let triangulations $\Omega^{(p)}$ such that $A \in N^{(p)}$ for any integer p (for $\Omega^{(p)}$ and $N^{(p)}$, see Definition 2.1 and 2.2) be given. If $u^{(p)}$ and u solve Problem (3.1) and (1.2), then*

$$u^{(p)} \rightarrow u \quad \text{in } V \text{ for } p \rightarrow +\infty.$$

Remark 4.3. Even if both bodies Ω' and Ω'' are “bolted” at a “wrong” point A (i.e. if the solution u of the main Problem (1.2) has no contact at this point: $[u]_v < 0$ at A), the approximations $u^{(p)}$ converge. However, the convergence may be very poor in the neighbourhood of the “bolt” A . This can, in fact, be deduced from the proof of Theorem 4.4.

Lemma 4.5. *Let a function $Z_{\theta,\delta}(r, \psi)$ be defined as follows for any $r \in [0, +\infty)$, $\psi \in [0, 2\pi)$ and parameters $\delta \in (0, 1)$, $\theta \in (0, 1)$: If $\psi \in [0, 2\pi)$ and*

$$\text{if } r \in [0, \delta e^{-2/\theta}] \text{ then } Z_{\theta,\delta}(r, \psi) = 0,$$

$$\text{if } r \in [\delta e^{-2/\theta}, \delta] \text{ then } Z_{\theta,\delta}(r, \psi) = 1 - \frac{\theta}{2} \log \frac{\delta}{r},$$

$$\text{if } r > \delta \quad \text{then } Z_{\theta,\delta}(r, \psi) = 1.$$

Then

$$Z_{\theta,\delta} \rightarrow 1 \quad \text{in } W^{1,2}(\mathbb{R}_2)$$

for $\theta \rightarrow 0_+$ and $\delta \rightarrow 0_+$.

Proof consists in routine calculation only.

Remark 4.4. By virtue of the regularisation technique (see [6], Theorem 2.1, page 60) one can easily conclude from Lemma 4.5 that there exists a family of functions $\tilde{Z}_{\theta,\delta} = \tilde{Z}_{\theta,\delta}(r, \psi)$, $r \in [0, +\infty)$, $\psi \in [0, 2\pi)$ for parameters $\theta \in (0, 1)$, $\delta \in (0, 1)$ such that

$$\tilde{Z}_{\theta,\delta} \in E(\mathbb{R}_2),$$

$$\tilde{Z}_{\theta,\delta} \rightarrow 1 \quad \text{in } W^{1,2}(\mathbb{R}_2) \quad \text{as } \theta \rightarrow 0_+, \quad \delta \rightarrow 0_+,$$

$$\tilde{Z}_{\theta,\delta} \equiv 0 \quad \text{for } r \in \left[0, \frac{\delta}{2} e^{-2/\theta}\right].$$

$$\tilde{Z}_{\theta,\delta} \equiv 1 \quad \text{for } r > 2\delta.$$

Lemma 4.6. *Let $A \in \Gamma$ be given. Then for any $w \in K$ there exists a sequence $\{w_\varepsilon\}_{\varepsilon \in (0,1)}$ such that $w_\varepsilon = [w_{1,\varepsilon}, w_{2,\varepsilon}] \in K$,*

$$w'_{i,\varepsilon} \in E(\Omega'), \quad w''_{i,\varepsilon} \in E(\Omega'') \quad \text{for } i = 1, 2,$$

$$w_\varepsilon = 0 \quad \text{at } A,$$

$$w_\varepsilon \rightarrow w \quad \text{for } \varepsilon \rightarrow 0_+ \text{ in the space } V.$$

Proof. According to assumption (A) there exists a sequence $\{v_\varepsilon\}_{\varepsilon \in (0,1)}$ satisfying all demands described above *except* the condition $v_\varepsilon = 0$ at A . Let us transform the function $\tilde{Z}_{\theta,\delta}$ (see Remark 4.4) into a Cartesian coordinate system with the origin at the point A . Then we can find $\theta = \theta(\varepsilon)$, $\delta = \delta(\varepsilon)$ such that $\|v_\varepsilon - \tilde{Z}_{\theta,\delta} v_\varepsilon\| \leq \varepsilon$, see Lemma 4.5. Thus it is sufficient to set $w_\varepsilon \equiv \tilde{Z}_{\theta,\delta} v_\varepsilon$.

Proof of Theorem 4.4. We can use exactly the same arguments as those in Section 4.2 with the following changes:

- (i) replace assumption (A) by the assertion of Lemma 4.6;
- (ii) replace Problem (2.1) by Problem (3.1);
- (iii) replace the space $V^{(p)}$ by the space $V_A^{(p)}$.

5. SMOOTH APPROXIMATION OF K

We start with

Definition 5.1. Let $\tilde{\Gamma}$ be the symmetric extension of Γ about the x_2 -axis, i.e.

$$\tilde{\Gamma} \equiv \Gamma \cup \{x \in \mathbb{R}_2; x = (x_1, x_2) \text{ such that } (-x_1, x_2) \in \Gamma\},$$

see Fig. 4.

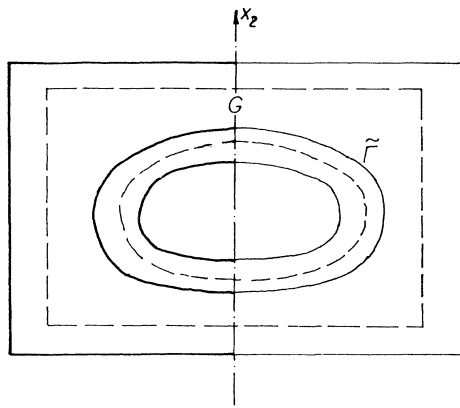

Fig. 4.

The purpose of this chapter is the proof of the following.

Theorem 5.1. If $\tilde{\Gamma}$ is an infinitely smooth Jordan curve then Assumption (A) from Chapter 4 is satisfied, i.e.

$\forall w \in K$ there exists a sequence $\{w_\varepsilon\}_{\varepsilon \in (0,1)}$ such that

- (i) $w_\varepsilon = [w_{1,\varepsilon}, w_{2,\varepsilon}] \in K$,
- (ii) $w'_{i,\varepsilon} \in E(\Omega')$, $w''_{i,\varepsilon} \in E(\Omega'')$ for $i = 1, 2$,
- (iii) $w_\varepsilon \rightarrow w$ in V for $\varepsilon \rightarrow 0_+$.

The proof of the theorem will be based on five lemmas. In the following we shall assume automatically that the assumptions of Theorem 5.1 concerning the smoothness of $\tilde{\Gamma}$ are satisfied.

Definition 5.2. Let G be a simply connected domain in \mathbb{R}_2 such that $\tilde{\Gamma} \subset G$ and $G \cap \{\Gamma_1 \cup \Gamma_2 \cup \Gamma_5\} = \emptyset$ and G is symmetric about the x_2 -axis. Let $\tilde{\Omega}'$ and $\tilde{\Omega}''$ be the symmetric extensions of Ω' and Ω'' about the x_2 -axis; see Fig. 4.

Lemma 5.1. There exists a linear continuous operator

$$Z : W^{1/2,2}(\tilde{\Gamma}) \rightarrow W^{1,2}(G)$$

such that

$$(5.1) \quad Z\psi = \psi \text{ on } \tilde{\Gamma} \text{ in the trace sense ;}$$

$$(5.2) \quad \text{if } \psi \in W^{1/2,2}(\tilde{\Gamma}) \text{ then } \text{supp } Z\psi \subset G ;$$

$$(5.3) \quad \text{moreover, if } \psi \leq 0 \text{ a.e. on } \tilde{\Gamma} \text{ then } Z\psi \leq 0 \text{ a.e. on } G ;$$

$$(5.4) \quad \text{if } \psi \in W^{k-1/2,2}(\tilde{\Gamma}) \text{ then } Z\psi \in W^{k,2}(G \cap \Omega') \cap W^{k,2}(G \cap \Omega'') \\ \text{for any integer } k .$$

Proof. For the proof see [6], Theorem 5.7, page 103, The quoted proof does not assert (5.3) explicitly. One can check very easily that the operator Z constructed in [6] satisfies the condition (5.3).

Remark 5.1. As a consequence of (5.4) we obtain the following results: If ψ is infinitely differentiable on $\tilde{\Gamma}$ then

$$(Z\psi)' \in E(\Omega'), \quad (Z\psi)'' \in E(\Omega'')$$

and

$$\text{supp } Z\psi \subset G .$$

Definition 5.3. We define the odd and even parts of the operator Z (see Lemma 5.1) as follows: If $\psi \in W^{1/2,2}(\tilde{\Gamma})$ and $(x_1, x_2) \in G$ then

$$Z^{(e)}\psi|_{x=(x_1, x_2)} \equiv \frac{1}{2}Z\psi|_{x=(x_1, x_2)} + \frac{1}{2}Z\psi|_{x=(-x_1, x_2)}$$

and

$$Z^{(0)}\psi|_{x=(x_1, x_2)} \equiv \frac{1}{2}Z\psi|_{x=(x_1, x_2)} - \frac{1}{2}Z\psi|_{x=(-x_1, x_2)} .$$

Lemma 5.2. The operators $Z^{(e)}$ and $Z^{(0)}$ are linear continuous operators mapping $W^{1/2,2}(\tilde{\Gamma})$ into $W^{1,2}(G)$. If $\psi^{(e)}$ and $\psi^{(0)}$ belong to $W^{1/2,2}(\tilde{\Gamma})$ and

$$\psi^{(e)}(x_1, x_2) = \psi^{(e)}(-x_1, x_2),$$

$$\psi^{(0)}(x_1, x_2) = -\psi^{(0)}(-x_1, x_2)$$

for $(x_1, x_2) \in \tilde{\Gamma}$, then

$$(5.5) \quad \text{supp } Z^{(e)}\psi^{(e)} \subset G, \quad \text{supp } Z^{(0)}\psi^{(0)} \subset G,$$

$$(5.6) \quad Z^{(e)}\psi^{(e)} = Z^{(0)}\psi^{(0)} = \psi^{(0)} \text{ on } \tilde{\Gamma} \text{ in the trace sense ,}$$

(5.7) if $\psi^{(e)} \leq 0$ a.e. on Γ then $Z^{(e)}\psi^{(e)} \leq 0$ a.e. on G ,

(5.8) if $\psi^{(e)}$ and $\psi^{(0)}$ are infinitely differentiable on $\tilde{\Gamma}$ then

$$Z^{(e)}\psi^{(e)} \in E(\Omega') \cap E(\Omega'')$$

and

$$Z^{(0)}\psi^{(0)} \in E(\Omega') \cap E(\Omega''),$$

(5.9) $Z^{(e)}\psi^{(e)}|_{\mathbf{x}=(x_1, x_2)} = Z^{(e)}\psi^{(e)}|_{\mathbf{x}=(-x_1, x_2)}$,

$$Z^{(0)}\psi^{(0)}|_{\mathbf{x}=(x_1, x_2)} = Z^{(0)}\psi^{(0)}|_{\mathbf{x}=(-x_1, x_2)} \text{ for } (x_1, x_2) \in G.$$

Proof follows immediately from Lemma 5.1 and Definition 5.3.

Remark 5.2. Let us keep the notation of Lemma 5.2. In the following we shall assume that the functions $Z^{(e)}\psi^{(e)}$ and $Z^{(0)}\psi^{(0)}$ are extended by zero outside G . Then, with respect to (5.5), we can state that $Z^{(e)}\psi^{(e)}$ and $Z^{(0)}\psi^{(0)}$ belong to $W^{1,2}(\mathbb{R}_2)$.

Definition 5.4. If $w = [w_1, w_2] \in V$ then $\tilde{w} = [\tilde{w}_1, \tilde{w}_2]$ is the vector function on $\tilde{\Omega}' \cup \tilde{\Omega}''$ defined by

$$\tilde{w}_i(x_1, x_2) = (-1)^i \tilde{w}_i(-x_1, x_2)$$

for $x = (x_1, x_2) \in \tilde{\Omega}' \cup \tilde{\Omega}''$, $i = 1, 2$ and

$$\tilde{w}_i(x_1, x_2) = w_i(x_1, x_2)$$

for $x = (x_1, x_2) \in \Omega' \cup \Omega''$, $i = 1, 2$. Symbols \tilde{w}'_i and \tilde{w}''_i denote the restrictions of \tilde{w}_i on $\tilde{\Omega}'$ and $\tilde{\Omega}''$ for $i = 1, 2$.

Moreover, if $v = (v_1, v_2)$ is the outward normal vector on $\tilde{\Gamma}$ with respect to $\tilde{\Omega}'$ then we set

$$\tilde{w}'_v \equiv \tilde{w}'_1 v_1 + \tilde{w}'_2 v_2,$$

$$\tilde{w}'_\tau \equiv \tilde{w}'_1 v_2 - \tilde{w}'_2 v_1,$$

$$\tilde{w}''_v \equiv \tilde{w}''_1 v_1 + \tilde{w}''_2 v_2,$$

$$\tilde{w}''_\tau \equiv \tilde{w}''_1 v_2 - \tilde{w}''_2 v_1$$

on $\tilde{\Gamma}$ in the trace sense.

Remark 5.3. It is easy to verify that $\tilde{w}_i \in W^{1,2}(\tilde{\Omega}') \cap W^{1,2}(\tilde{\Omega}'')$. As a consequence of the theorem concerning traces (see [6], Theorem 5.5, page 99) we have $\tilde{w}'_i, \tilde{w}''_i \in W^{1/2,2}(\tilde{\Gamma})$ and hence $\tilde{w}'_v, \tilde{w}'_\tau, \tilde{w}''_v, \tilde{w}''_\tau \in W^{1/2,2}(\tilde{\Gamma})$; remember that v_1, v_2 are infinitely smooth on $\tilde{\Gamma}$.

Definition 5.5. For $w \in V$ we set (see Remark 5.2)

$$\left. \begin{aligned} v'_1 &\equiv Z^{(0)}v_1 \cdot Z^{(e)}\tilde{w}'_v + Z^{(e)}v_2 \cdot Z^{(0)}\tilde{w}'_\tau \\ v'_2 &\equiv Z^{(e)}v_2 \cdot Z^{(e)}\tilde{w}'_v - Z^{(0)}v_1 \cdot Z^{(0)}\tilde{w}'_\tau \end{aligned} \right\} \text{ on } \tilde{\Omega}'$$

and

$$\left. \begin{aligned} v_1'' &\equiv Z^{(0)}v_1 \cdot Z^{(e)}\tilde{w}_v'' + Z^{(e)}v_2 \cdot Z^{(0)}\tilde{w}_\tau'' \\ v_2'' &\equiv Z^{(e)}v_2 \cdot Z^{(e)}\tilde{w}_v'' - Z^{(0)}v_1 \cdot Z^{(0)}\tilde{w}_\tau'' \end{aligned} \right\} \text{ on } \tilde{\Omega}'',$$

where \tilde{w}_v and \tilde{w}_τ are given by Definition 5.4.

Lemma 5.3. *If $w \in V$ and the functions \tilde{w} , v are given by Definitions 5.4, 5.5 then*

$$(5.10) \quad \tilde{w} - v \in V,$$

$$(5.11) \quad \tilde{w} - v = w \quad \text{on } \Omega \setminus G,$$

$$(5.12) \quad \begin{aligned} (\tilde{w}_i - v_i)|_{x=(x_1, x_2)} &= (-1)^i \cdot (\tilde{w}_i - v_i)|_{x=(-x_1, x_2)} \\ \forall (x_1, x_2) \in \tilde{\Omega}' \cup \tilde{\Omega}'' &, \quad i = 1, 2, \end{aligned}$$

$$(5.13) \quad \tilde{w}_i - v_i \in W^{1,2}(\Omega), \quad i = 1, 2.$$

Proof. It can be verified that the functions v_2 , \tilde{w}'_v , \tilde{w}''_v and the functions v_1 , \tilde{w}'_τ , \tilde{w}''_τ satisfy the assumptions of Lemma 5.2 concerning the functions $\psi^{(e)}$ and $\psi^{(0)}$, respectively. The assertions (5.12) and (5.11) are then consequences of (5.9) and (5.5).

From (5.6) and (5.12) it follows that

$$(5.14) \quad \begin{aligned} \tilde{w}'_i - v'_i &= 0, \\ \tilde{w}''_i - v''_i &= 0 \end{aligned}$$

on Γ in the trace sense for $i = 1, 2$ and

$$(5.15) \quad \begin{aligned} \tilde{w}'_1 - v'_1 &= 0 \quad \text{on } \Gamma_3, \\ \tilde{w}''_1 - v''_1 &= 0 \quad \text{on } \Gamma_4 \end{aligned}$$

in the trace sense. Remember again that v_1, v_2 are infinitely smooth and hence the assumptions of (5.8) are satisfied. Then (5.13) and (5.10) follow from (5.14) and (5.15), (5.11).

Definition 5.6. *If $\psi \in L_{1,\text{loc}}(\mathbb{R}_2)$ and $\text{supp } \psi$ is compact in \mathbb{R}_2 then*

$$\omega_\varepsilon * \psi = \psi_\varepsilon(x) \equiv \frac{1}{\kappa \varepsilon^2} \int_{\left\{ \substack{\text{supp } \psi \\ |x-y| \leq \varepsilon} \right\}} \psi(y) \exp \frac{|x-y|^2}{|x-y|^2 - \varepsilon^2} dy$$

$\forall \varepsilon > 0, \forall x \in \mathbb{R}_2$, where

$$\kappa = \int_{\tilde{x} \leq 1} \exp \frac{|x|^2}{|x|^2 - 1} dx.$$

Remark 5.4. If $\psi \in W^{1,2}(G)$, $\text{supp } \psi \subset G$ then $\omega_\varepsilon * \psi \in E(G)$ and $\text{supp } (\omega_\varepsilon * \psi) \subset G$ for $\varepsilon > 0$ sufficiently small. From [8], Theorem 2.1, page 60 it follows that

$$\|(\omega_\varepsilon * \psi) - \psi\|_{W^{1,2}(G)} \rightarrow 0 \quad \text{for } \varepsilon \rightarrow 0_+.$$

Moreover, if $\psi(x_1, x_2) = \psi(-x_1, x_2)$ or $\psi(x_1, x_2) = -\psi(-x_1, x_2)$, respectively, then

$$\omega_\varepsilon * \psi|_{x=(x_1, x_2)} = \omega_\varepsilon * \psi|_{x=(-x_1, x_2)}$$

or

$$\omega_\varepsilon * \psi|_{x=(x_1, x_2)} = -\omega_\varepsilon * \psi|_{x=(-x_1, x_2)}$$

for $(x_1, x_2) \in G$.

Definition 5.7. If $w \in V$ and the functions \tilde{w} , v are given by Definitions 5.4, 5.5 then we set

$$v_\varepsilon = [v_{1,\varepsilon}, v_{2,\varepsilon}]$$

for any $\varepsilon > 0$, where (see Remark 5.2)

$$v'_{1,\varepsilon} \equiv Z^{(0)}v_1 \cdot (\omega_\varepsilon * Z^{(e)}\tilde{w}'_v) + Z^{(0)}v_2 \cdot (\omega_\varepsilon * Z^{(0)}\tilde{w}'_t),$$

$$v'_{2,\varepsilon} \equiv Z^{(e)}v_2 \cdot (\omega_\varepsilon * Z^{(e)}\tilde{w}'_v) - Z^{(0)}v_1 \cdot (\omega_\varepsilon * Z^{(0)}\tilde{w}'_t)$$

on $\tilde{\Omega}'$ and

$$v''_{1,\varepsilon} \equiv Z^{(0)}v_1 \cdot (\omega_\varepsilon * Z^{(e)}\tilde{w}''_v) + Z^{(0)}v_2 \cdot (\omega_\varepsilon * Z^{(0)}\tilde{w}''_t),$$

$$v''_{2,\varepsilon} \equiv Z^{(e)}v_2 \cdot (\omega_\varepsilon * Z^{(e)}\tilde{w}''_v) - Z^{(0)}v_1 \cdot (\omega_\varepsilon * Z^{(0)}\tilde{w}''_t)$$

on $\tilde{\Omega}''$.

Lemma 5.4. If $w \in V$ and the functions \tilde{w} , v , v_ε are given by Definitions 5.4, 5.5, 5.7 then the following assertions hold for any $\varepsilon > 0$ sufficiently small:

$$(5.16) \quad v'_{i,\varepsilon} \in E(\tilde{\Omega}'), \quad v''_{i,\varepsilon} \in E(\tilde{\Omega}''), \quad i = 1, 2,$$

$$(5.17) \quad \text{supp } v_{i,\varepsilon} \subset G, \quad i = 1, 2,$$

$$(5.18) \quad v_\varepsilon \in V,$$

$$(5.19) \quad [v_\varepsilon]_v = \omega_\varepsilon * Z^{(e)}[\tilde{w}]_v \quad \text{a.e. on } \tilde{\Gamma},$$

$$(5.20) \quad \|v - v_\varepsilon\| \rightarrow 0 \quad \text{for } \varepsilon \rightarrow 0_+.$$

Proof. The assertions (5.16)–(5.18), (5.20) are easy consequences of Lemma 5.2 and Remark 5.4. It is sufficient only to realise that the functions v_2 , \tilde{w}'_v , \tilde{w}''_v are even and v_1 , \tilde{w}'_t , \tilde{w}''_t are odd on Γ with respect to the x_2 -axis. Moreover, v_1 and v_2 are infinitely differentiable.

The assertion (5.19) follows by direct computation.

Lemma 5.5. *If $w \in V$ and the function v is given via Definition 5.5, then we set $z \equiv w - v$. For any $\varepsilon > 0$ there exists $z_\varepsilon = [z_{1,\varepsilon}, z_{2,\varepsilon}] \in V$ such that*

$$z_{i,\varepsilon} \in E(\Omega), \quad i = 1, 2$$

and

$$\|z_\varepsilon - z\| \rightarrow 0 \quad \text{for } \varepsilon \rightarrow 0_+.$$

Proof. According to Lemma 5.3, the functions z_1, z_2 have the following properties:

$$\begin{aligned} z_1, z_2 &\in W^{1,2}(\Omega), \\ z_1 = z_2 &= 0 \quad \text{a.e. on } \Gamma_2, \\ z_1 &= 0 \quad \text{a.e. on } \Gamma_3 \cup \Gamma_4. \end{aligned}$$

Finally, we recall the assumption from Chapter 1 that the boundary $\partial\Omega$ of Ω is Lipschitz continuous. Hence we can use the standard regularisation techniques for the proof – see [8], Theorem 2.1, page 60.

Proof of Theorem 5.1. If $w \in K$ then we set

$$w_\varepsilon \equiv z_\varepsilon + v_\varepsilon \quad \forall \varepsilon > 0,$$

where z_ε and v_ε are given by Lemma 5.5 and Definition 5.7.

The assertions (ii), (iii) of Theorem 5.1 and

$$(5.21) \quad w_\varepsilon \in V \quad \forall \varepsilon > 0,$$

follow easily from Lemma 5.4 and 5.5. Hence it remains to show that

$$(5.22) \quad [w_\varepsilon]_v \leq 0 \quad \text{a.e. on } \Gamma \quad \forall \varepsilon > 0.$$

Then the assertion (i) follows from (5.21) and (5.22).

As $z_{i,\varepsilon} \in E(\Omega)$, see Lemma 5.5, we have $[w_\varepsilon]_v = [v_\varepsilon]_v$. With respect to (5.19) we obtain that

$$[w_\varepsilon]_v = \omega_\varepsilon * Z^{(e)}[\tilde{w}]_v \quad \text{a.e. on } \tilde{\Gamma}.$$

We can easily verify that $[\tilde{w}]_v$ is an even function on $\tilde{\Gamma}$ (with respect to the x_1 -axis). Moreover, the function $[\tilde{w}]_v$ equals $[w]_v$ on Γ and hence $[\tilde{w}]_v \leq 0$ on Γ . As a consequence of (5.7) and Remark 5.2 we obtain that

$$Z^{(e)}[\tilde{w}]_v \leq 0 \quad \text{a.e. on } \mathbb{R}_2.$$

Finally, according to Definition 5.6 we can show that

$$\omega_\varepsilon * Z^{(e)}[\tilde{w}]_v \leq 0 \quad \text{on } \mathbb{R}_2 \quad (\text{and the more on } \Gamma).$$

6. APPROXIMATION PROPERTIES OF THE SPACES $V^{(p)}$

The following Definitions 6.1–6.3 are introduced in order to facilitate the description of triangulation $\Omega^{(p)}$, see Definition 2.1.

Definition 6.1. *If two vertices of a (curved) triangle $\Omega_{i,p} \in \Omega^{(p)}$ lie on Γ then $\Omega_{i,p}$ is called a contact element. If two vertices of a (curved) triangle $\Omega_{i,p} \in \Omega^{(p)}$ lie on $\Gamma_1 \cup \Gamma_2 \cup \Gamma_5$ then $\Omega_{i,p}$ is called a boundary element; see Fig. 5.*

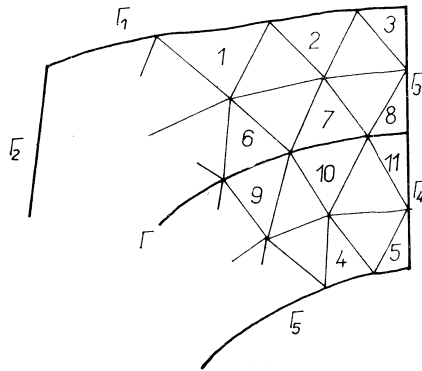

Fig. 5. 1–5 boundary elements, 6–11 contact elements.

Convention. (Numbering of vertices.) If $\Omega_{i,p} \in \Omega^{(p)}$ is either a contact element or a boundary element, then we denote its vertices by A_1, A_2, A_3 so that A_1 and A_2 are the two vertices which lie either on Γ or on $\Gamma_1 \cup \Gamma_2 \cup \Gamma_5$; see Fig. 6.

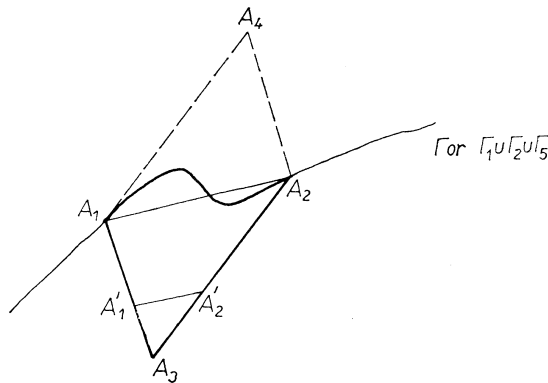

Fig. 6 (for $\gamma = \frac{1}{3}$).

Definition 6.2. Let $\Omega_{i,p} \in \Omega^{(p)}$ be either a contact element or a boundary element with vertices A_1, A_2, A_3 . Let A_4 be the point symmetric to A_3 about the mid-point of the segment A_1A_2 . Let A'_1 and A'_2 be two points on the sides A_1A_3 and A_2A_3 , respectively, satisfying $\text{dist}(A'_1, A_3) = \gamma \text{dist}(A_1, A_3)$ and $\text{dist}(A'_2, A_3) = \gamma \text{dist}(A_2, A_3)$ where γ is a fixed constant, $0 < \gamma < 1$. Then

$\omega_{i,p}$ is the parallelogram with vertices A_1, A_3, A_2, A_4 ,

$T_{i,p}$ is the triangle with vertices A_1, A_2, A_3 ,

$T'_{i,p}$ is the triangle with vertices A'_1, A'_2, A_3 .

(See Fig. 6.)

Definition 6.3. Let $\Omega_{i,p} \in \Omega^{(p)}$ and set

$T_{i,p} \equiv \mathcal{T}$ iff $\Omega_{i,p}$ is either a contact element or a boundary element,

$\Omega_{i,p} \equiv \mathcal{T}$ otherwise.

Then we define

$\sigma_{i,p}$ = perimeter of \mathcal{T} ,

$\varrho_{i,p}$ = diameter of the inscribed circle of \mathcal{T} .

Asymptotic properties of $\Omega^{(p)}$ as $p \rightarrow +\infty$, can now be formulated as follows:

Definition 6.4. A family of triangulations $\Omega^{(p)}$, $p = 1, 2, \dots$ is called a regular family provided that:

(i) There exist constants c_1, c_2 such that

$$\sigma_{i,p} \leq c_1 p^{-1},$$

$$\varrho_{i,p}^{-1} \leq c_2 p$$

for any positive integer p and for any $i = 1, \dots, K(p)$.

(ii) If $\Omega_{i,p} \in \Omega^{(p)}$ and $\Omega_{i,p}$ is a boundary or a contact element, then

$$T'_{i,p} \subset \Omega_{i,p}, \Omega_{i,p} \subset \omega_{i,p}$$

and

$\partial\Omega_{i,p}$ is star-shaped with respect to any inner point

$$x \in T'_{i,p}. \quad *)$$

(iii) If $\Omega_{i,p} \in \Omega^{(p)}$ is a contact element with vertices A_1, A_2, A_3 then any straight line parallel either to A_1A_3 or to A_2A_3 has only one common point with the curved side A_1A_2 , see Fig. 7.

*) This means that any ray with the origin at x has one and only one common point with $\partial\Omega_{i,p}$.

Now we give definitions required for the description of the technique of mapping $\Omega_{i,p}$ onto a fixed "reference" domain.

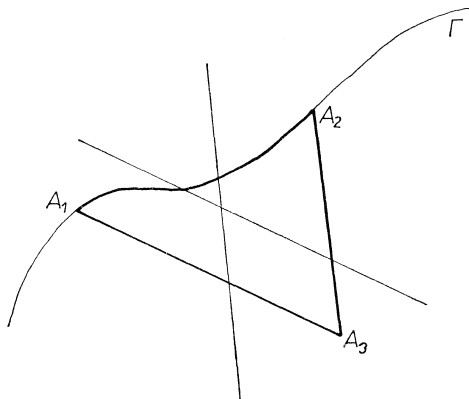

Fig. 7.

Definition 6.5. Denote by T the "reference" triangle with vertices $\bar{A}_3 \equiv (0, 0)$, $\bar{A}_2 \equiv (1, 0)$, $\bar{A}_1 \equiv (0, 1)$ and let $\Omega_{i,p} \in \Omega^{(p)}$ be an element with vertices A_1, A_2, A_3 . Then $F_{i,p}$ denotes the affine mapping $F_{i,p} : \mathbb{R}_2 \rightarrow \mathbb{R}_2$ such that

$$F_{i,p}(\bar{A}_k) = A_k \quad \text{for } k = 1, 2, 3.$$

Definition 6.6. Denote by R , T' and P , respectively, the reference square with vertices $\bar{A}_1, \bar{A}_2, \bar{A}_3, \bar{A}_4 \equiv (1, 1)$, the reference triangle T' with vertices $\bar{A}'_1 \equiv (0, \gamma)$, $\bar{A}'_2 \equiv (\gamma, 0)$, \bar{A}'_3 and the reference polygon P with vertices $\bar{A}_1, \bar{A}_3, \bar{A}_2, \bar{A}_5 \equiv (\gamma/2, \gamma/2)$; the constant γ is defined in Definition 6.2.

Definition 6.7. The range of $F_{i,p}^{-1}$ is defined as follows

$$\hat{\Omega}_{i,p} \equiv \{\hat{x} \in \mathbb{R}_2; \text{ there exists } x \in \Omega_{i,p} \text{ such that } x = F_{i,p}\hat{x}\};$$

see Fig. 8.

If ψ is a function on $\Omega_{i,p}$ then $\hat{\psi} \equiv \psi \circ F_{i,p}$ is a function on $\hat{\Omega}_{i,p}$.

Remark 6.1. If $F_{i,p}$ is the operator introduced in Definition 6.5 then there exists a "2 × 2" matrix $B_{i,p}$ and a vector $b_{i,p} \in \mathbb{R}_2$ such that

$$F_{i,p}x \equiv B_{i,p}x + b_{i,p}$$

for any $x \in \mathbb{R}_2$.

If we denote by $|\cdot|_{W^{k,2}(\Omega_{i,p})}$ the usual semi-norm on the Sobolev space $W^{k,2}(\Omega_{i,p})$ then we can prove, using a classical argument (see e.g. [1]), that

$$|\psi|_{W^{k,2}(\Omega_{i,p})} \leq |\det B_{i,p}|^{1/2} \|B_{i,p}^{-1}\|_{\mathbb{R}^2}^k |\hat{\psi}|_{W^{k,2}(\hat{\Omega}_{i,p})}$$

(convention: $W^{0,2} \equiv L_2$) and

$$|\hat{\psi}|_{W^{k,2}(\hat{\Omega}_{i,p})} \leq |\det B_{i,p}|^{-1/2} \|B_{i,p}\|_{\mathbb{R}^2}^k |\psi|_{W^{k,2}(\Omega_{i,p})}$$

for any integer k , where

$$\begin{aligned} \|B_{i,p}\|_{\mathbb{R}^2} &\leq \frac{6\sigma_{i,p}}{\sqrt{2}}, \\ \|B_{i,p}^{-1}\|_{\mathbb{R}^2} &\leq \frac{2 + \sqrt{2}}{\varrho_{i,p}}, \\ |\det B_{i,p}| &\leq 2\sigma_{i,p}^2, \\ |\det B_{i,p}^{-1}| &\leq \frac{1}{2\pi} \varrho_{i,p}^{-2} \end{aligned}$$

\forall integer p , $\forall i = 1, \dots, K(p)$, $\forall \psi \in W^{k,2}(\Omega_{i,p})$.

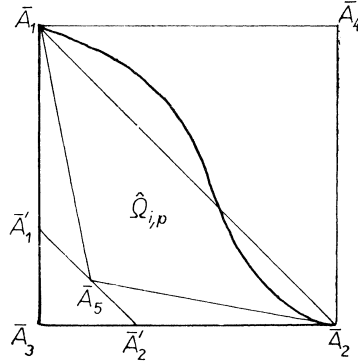

Fig. 8 (for $\gamma = \frac{1}{3}$).

Lemma 6.1. *If a family $\Omega^{(p)}$ is regular then there exist constants C_1, C_2 such that*

$$(6.1) \quad \|\psi\|_{W^{1,2}(\Omega_{i,p})} \leq C_1 \|\hat{\psi}\|_{W^{1,2}(\hat{\Omega}_{i,p})}$$

and

$$(6.2) \quad \begin{aligned} \|\hat{\psi}\|_{L_2(\hat{\Omega}_{i,p})} &\leq C_2 p \|\psi\|_{L_2(\Omega_{i,p})}, \\ \|\hat{\psi}\|_{W^{1,2}(\hat{\Omega}_{i,p})} &\leq C_2 |\psi|_{W^{1,2}(\Omega_{i,p})}, \\ |\hat{\psi}|_{W^{2,2}(\hat{\Omega}_{i,p})} &\leq C_2 p^{-1} |\psi|_{W^{2,2}(\Omega_{i,p})} \end{aligned}$$

\forall integer p , $\forall i = 1, \dots, K(p)$, $\forall \psi \in W^{2,2}(\Omega_{i,p})$.

Proof. The proof follows directly from Remark 6.1 and Definition 6.4.

Lemma 6.2. *If G_1, G_2 are simply connected domains, $\bar{G}_1 \subset G_2$ and k is an integer, then there exists a constant C_0 such that*

$$(6.3) \quad \inf_{\chi \in P_{k-1}} \|u + \chi\|_{W^{k,2}(G)} \leq C_0 |u|_{W^{k,2}(G)},$$

where P_{k-1} denotes the space of all polynomials of a degree less or equal to $k - 1$, $\forall u \in W^{k,2}(G)$, $\forall G : G_1 \subset G \subset G_2$, ∂G is star-shaped with respect to G_1 (i.e. if $\tilde{x} \in G_1$ then any ray with the origin at \tilde{x} intersects ∂G at one and only one point).

Proof. See Appendix.

Theorem 6.1. *If a family $\Omega^{(p)}$ is regular (see Definition 6.4) then the assumption (A1) from Chapter 4 is satisfied.*

Proof. If $w \in V$, $w = [w_1, w_2]$, $w'_j \in E(\Omega')$, $w''_j \in E(\Omega'')$ then we define $w^{(p)} \in V^{(p)}$ so that

$$\left. \begin{aligned} (w_j^{(p)})' &= w'_j, \\ (w_j^{(p)})'' &= w''_j \end{aligned} \right\} \text{ for } j = 1, 2$$

at any nodal point Q , i.e. $w^{(p)}$ interpolates w . As $[w^{(p)}]_v = [w]_v$ on $N^{(p)}$, it remains to show that $w^{(p)} \rightarrow w$ in V . We use a classical argument and give a sketch of the proof only.

We shall investigate the norms

$$\|w_j - w_j^{(p)}\|_{W^{1,2}(\Omega_{i,p})}$$

for $j = 1, 2$ and $i = 1, \dots, K(p)$ and an integer p . In accordance with (6.1) it is

$$(6.4) \quad \|w_j - w_j^{(p)}\|_{W^{1,2}(\Omega_{i,p})} \leq C_1 \|\hat{w}_j - \hat{w}_j^{(p)}\|_{W^{1,2}(\hat{\Omega}_{i,p})}.$$

First we deal with the most difficult case that $\Omega_{i,p}$ is either a boundary element or a contact one. From Definitions 6.4–6.7 we can easily derive that $\partial\hat{\Omega}_{i,p}$ is star-shaped with respect to any inner point $x \in T'$ so that

$$P \subset \hat{\Omega}_{i,p} \subset R.$$

Since $\hat{w}_j^{(p)}$ is linear over $\hat{\Omega}_{i,p}$, there exist constants C_3, C_4 (independent of i, p, w) such that

$$\|\hat{w}_j^{(p)}\|_{W^{1,2}(\hat{\Omega}_{i,p})} \leq C_3 \|\hat{w}_j^{(p)}\|_{W^{1,2}(R)} \leq C_4 \|\hat{w}_j^{(p)}\|_{C(P)}.$$

By means of the continuous embedding $W^{2,2}(P)$ into $C(P)$ we can verify that there exists a constant C_5 (independent of i, p, w) such that

$$(6.5) \quad \|\hat{w}_j^{(p)}\|_{W^{1,2}(\hat{\Omega}_{i,p})} \leq C_5 \|\hat{w}_j\|_{W^{2,2}(P)} \leq C_5 \|\hat{w}_j\|_{W^{2,2}(\hat{\Omega}_{i,p})}.$$

As a consequence of (6.4) and (6.5) there exists a constant C_6 (independent of i, p, w) such that

$$(6.6) \quad \|w_j - w_j^{(p)}\|_{W^{1,2}(\Omega_{i,p})} \leq C_6 \|\hat{w}_j\|_{W^{2,2}(\hat{\Omega}_{i,p})}.$$

Because $w_j^{(p)}$ is the piecewise linear interpolant of w_j , it could be easily shown that

$$\text{if } w_j \text{ is linear on } \Omega_{i,p} \text{ then } w_j^{(p)} \equiv w_j \text{ on } \Omega_{i,p}.$$

This means that (6.6) can be replaced by

$$(6.7) \quad \|w_j - w_j^{(p)}\|_{W^{1,2}(\Omega_{i,p})} \leq C_6 \|\hat{w}_j + \chi\|_{W^{2,2}(\hat{\Omega}_{i,p})}$$

for any $\chi \in P_1$.

Now, we use Lemma 6.2 with $G_2 \equiv R$ and G_1 a fixed ball inside T' . Then (6.7) implies

$$(6.8) \quad \|w_j - w_j^{(p)}\|_{W^{1,2}(\Omega_{i,p})} \leq C_6 C_0 |\hat{w}_j|_{W^{2,2}(\hat{\Omega}_{i,p})}.$$

Finally, using (6.2) we derive from (6.8) that

$$(6.9) \quad \|w_j - w_j^{(p)}\|_{W^{1,2}(\Omega_{i,p})} \leq C_6 C_0 C_2 p^{-1} |w_j|_{W^{2,2}(\Omega_{i,p})}.$$

In the case that $\Omega_{i,p}$ is neither a contact nor a boundary element, we can reach the same result (6.9). The proof is similar to the previous case and hence we omit it.

As a direct consequence of (6.9) we have

$$\|w - w^{(p)}\| \leq C_0 C_2 C_6 p^{-1} \left(\sum_{j=1}^2 (|w_j|_{W^{2,2}(\Omega')}^2 + |w_j'|_{W^{2,2}(\Omega'')}^2) \right)^{1/2},$$

i.e.

$$\|w - w^{(p)}\| \rightarrow 0 \quad \text{for } p \rightarrow +\infty.$$

We proceed with the verification of assumption (A2) from Chapter 4 and start with

Definition 6.8. Let $\{\tau_{i,p}\}_{i=1}^{k(p)} \equiv \tau^{(p)}$ be the partition introduced in Definition 2.2. For any $\tau_{i,p} \in \tau^{(p)}$ there exist unique boundary elements $K' \in \Omega^{(p)}$ and $K'' \in \Omega^{(p)}$ such that

$$K' \subset \Omega' \quad \text{and} \quad K'' \subset \Omega''$$

$$K' \cap \Gamma = K'' \cap \Gamma = \tau_{i,p}.$$

For this K' (or K'') we set

$\hat{\tau}_{i,p} = \{\hat{x} \in \mathbb{R}_2; \text{ there exists } x \in K' \text{ (or } K'') \text{ such that } x = F\hat{x}, \text{ where } F \text{ is the affine mapping which corresponds to } K' \text{ (or } K'') \text{ via Definition 6.5}\}.$

If ψ is a function on $\tau_{i,p}$ then $\hat{\psi} \equiv \psi \circ F$ is a function on $\hat{\tau}_{i,p}$, where F is the affine mapping which corresponds to K' (or K'') via Definition 6.5.

Lemma 6.3. *If a family $\Omega^{(p)}$ is regular then there exists a constant C_7 such that*

$$\|\psi\|_{L_2(\tau_{i,p})} \leq C_7 p^{-1/2} \|\hat{\psi}\|_{L_2(\hat{\tau}_{i,p})}$$

\forall integer $p, \forall i = 1, \dots, k(p), \forall \tau_{i,p} \in \tau^{(p)}, \forall \psi \in L_2(\tau_{i,p})$.

Proof. Let K'' be the contact element corresponding to a given $\tau_{i,p}$ via Definition 6.8. We denote by A_1, A_2, A_3 the vertices of K'' ; in accordance with the convention it is $A_1 \in \Gamma, A_2 \in \Gamma, A_3 \in \Omega''$. For any straight line p parallel to A_1A_3 we denote by X, Y_1 and Y respectively the intersection of p with Γ , the straight line A_1A_2 and the side A_2A_3 ; see Fig. 9.

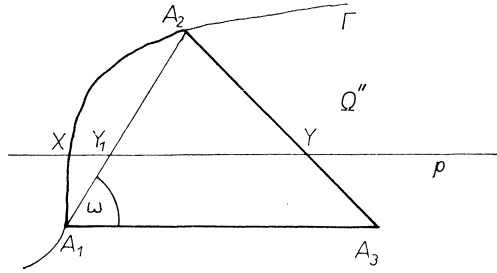

Fig. 9.

We set $e \equiv \text{dist}(A_1, A_3), d \equiv \text{dist}(A_2, A_3), a \equiv \text{dist}(A_1, A_2)$. If $\text{dist}(Y, A_3) = \alpha \cdot d$ for a parameter $\alpha, 0 \leq \alpha \leq 1$, then $\text{dist}(Y_1, Y) = (1 - \alpha) \cdot e$. Further we set

$$\beta \equiv (\text{dist}(X, Y_1)) \cdot (\text{dist}(Y_1, Y))^{-1}.$$

We can consider the value β as a function of the parameter α , i.e. $\beta = \beta(\alpha)$. Using the assumption concerning the smoothness of Γ and the assumption (ii) from Definition 6.4, it can be shown that $\beta = \beta(\alpha)$ is infinitely differentiable on $[0, 1]$, i.e. $\beta \in C^\infty([0, 1])$.

It is apparent that the coordinates of the point $X = (x_1, x_2)$ can be understood as a function of α , i.e.

$$X = (x_1(\alpha), x_2(\alpha)).$$

Making the relevant substitution, we can show that

$$\begin{aligned} (6.10) \quad \|\psi\|_{L_2(\tau_{i,p})}^2 &= a \int_0^1 |\psi(x_1(\alpha), x_2(\alpha))|^2 \left(1 - 2(\beta'(\alpha)(1 - \alpha) - \beta(\alpha)) \frac{e}{a} \cos \omega + \right. \\ &\quad \left. + (\beta'(\alpha)(1 - \alpha) - \beta(\alpha))^2 \frac{e^2}{a^2} \right)^{1/2} d\alpha \leq \\ &\leq 2a \int_0^1 |\psi(x_1(\alpha), x_2(\alpha))|^2 \left(1 + (\beta'(\alpha)(1 - \alpha) - \beta(\alpha))^2 \frac{e^2}{a^2} \right)^{1/2} d\alpha, \end{aligned}$$

where ω is the angle between the lines A_1A_2 and A_1A_3 ; see Fig. 9. We can check that

$$\begin{aligned} \text{if } \hat{X} &\equiv F^{-1}X, \quad \hat{Y}_1 \equiv F^{-1}Y, \quad \hat{Y} \equiv F^{-1}Y_1 \\ \text{then } \beta(\alpha) &= (\text{dist}(\hat{X}, \hat{Y}_1))(\text{dist}(\hat{Y}_1, \hat{Y}))^{-1}. \end{aligned}$$

Using the fact above we can derive that

$$\begin{aligned} (6.11) \quad \|\hat{\psi}\|_{L_2(\tau_{i,p})}^2 &= \sqrt{2} \int_0^1 |\psi(x_1(\alpha), x_2(\alpha))|^2 (1 - \beta'(\alpha)(1 - \alpha) + \beta(\alpha) + \\ &\quad + (\beta'(\alpha)(1 - \alpha) - \beta(\alpha))^2 \frac{1}{2})^{1/2} d\alpha = \\ &= \int_0^1 |\psi(x_1(\alpha), x_2(\alpha))|^2 (1 + (1 - \beta'(\alpha)(1 - \alpha) + \beta(\alpha))^2)^{1/2} d\alpha. \end{aligned}$$

Since

$$\frac{e}{a} \leq \frac{\sigma_{i,p}}{\varrho_{i,p}} \leq \frac{c_1}{c_2}$$

and

$$1 + q^2 \frac{e^2}{a^2} \leq \max\left(2, \frac{3e^2}{a^2}\right) (1 + (1 - q)^2) \quad \forall q \in (-\infty, \infty),$$

we obtain from (6.10) and (6.11) the estimate

$$(6.12) \quad \|\psi\|_{L_2(\tau_{i,p})}^2 \leq 2a \|\hat{\psi}\|_{L_2(\tau_{i,p})}^2 \max\left(2, 3 \frac{c_1^2}{c_2^2}\right),$$

where the constant a can be estimated as follows:

$$(6.13) \quad a \leq \text{meas}(\tau_{i,p}) \leq c_1 p^{-1}.$$

The estimates (6.12), (6.13) give the assertion of Lemma 6.3 immediately.

Lemma 6.4. *If a family $\Omega^{(p)}$ is regular then there exists a constant C_8 such that*

$$(6.14) \quad \|w'_j v_j - L^{(p)}(w'_j v_j)\|_{L_2(\Gamma)} \leq C_8 \|w'_j\|_{W^{1,2}(\Omega')} p^{-1/2}$$

and

$$(6.15) \quad \|w''_j v_j - L^{(p)}(w''_j v_j)\|_{L_2(\Gamma)} \leq C_8 \|w''_j\|_{W^{1,2}(\Omega'')} p^{-1/2},$$

where $L^{(p)}$ is defined in Definition 4.1, \forall integer p , $\forall w = [w_1, w_2] \in V^{(p)}$, $\forall j = 1, 2$.

Proof. We verify (6.14) only; the estimate (6.15) can be proved in the same way. Making use of the triangle inequality, we obtain (dropping the index)

$$\begin{aligned} (6.16) \quad \|w'v - L^{(p)}(w'v)\|_{L_2(\Gamma)} &\leq \|(w' - L^{(p)}w')v\|_{L_2(\Gamma)} + \\ &+ \|(L^{(p)}w')(L^{(p)}v) - L^{(p)}(w'v)\|_{L_2(\Gamma)} + \|(L^{(p)}w')(v - L^{(p)}v)\|_{L_2(\Gamma)}. \end{aligned}$$

We successively estimate all three terms on the right hand side of (6.16). To this purpose we choose an arbitrary $\tau_{i,p} \in \tau^{(p)}$ and denote by K' the relevant element from $\Omega^{(p)}$ via Definition 6.8.

(a) Lemma 6.3 yields

$$\|(w' - L^{(p)}w') v\|_{L_2(\tau_{i,p})} \leq C_7 p^{-1/2} \|(\widehat{w}' - \widehat{L^{(p)}w'}) \widehat{v}\|_{L_2(\widehat{\tau}_{i,p})}.$$

Apparently, there exists a constant C_9 (independent of p, i, w) such that

$$(6.17) \quad \|\widehat{v}\|_{L_\infty(\widehat{\tau}_{i,p})} \leq C_9.$$

Hence

$$\|(\widehat{w}' - \widehat{L^{(p)}w'}) \widehat{v}\|_{L_2(\widehat{\tau}_{i,p})} \leq C_9 \|\widehat{w}' - \widehat{L^{(p)}w'}\|_{L_2(\widehat{\tau}_{i,p})} \leq 2C_9 \|\widehat{w}'\|_{C(\widehat{\tau}_{i,p})} (\text{meas } \widehat{\tau}_{i,p})^{1/2}.$$

We remark that Definition 6.4 (assumption (iii)) implies

$$\text{meas } \widehat{\tau}_{i,p} \leq 2.$$

As the space of linear functions is finite-dimensional, there exists a constant C_{10} (independent of p, i, w) such that

$$\|\widehat{w}'\|_{C(\widehat{\tau}_{i,p})} \leq \|\widehat{w}'\|_{C(R)} \leq C_{10} \|\widehat{w}'\|_{W^{1,2}(T')} \leq C_{10} \|\widehat{w}'\|_{W^{1,2}(K')}.$$

The estimates above yield

$$(6.18) \quad \|(w' - L^{(p)}w') v\|_{L_2(\tau_{i,p})} \leq C_{11} p^{-1/2} \|\widehat{w}'\|_{W^{1,2}(K')},$$

where $C_{11} = 4C_7C_8C_9C_{10}$.

We can easily check that if \widehat{w}' is constant on \widehat{K}' then w' is constant on $\tau_{i,p}$ and hence $w' = L^{(p)}w'$ on $\tau_{i,p}$. This fact implies that (6.18) can be replaced by

$$(6.19) \quad \|(w' - L^{(p)}w') v\|_{L_2(\tau_{i,p})} \leq C_{11} \|\widehat{w}' + \chi\|_{W^{1,2}(K')} p^{-1/2}$$

for any constant χ . According to Lemmas 6.2 and 6.1, we can estimate

$$(6.20) \quad \inf_{\chi = \text{const.}} \|\widehat{w}' + \chi\|_{W^{1,2}(K')} \leq C_0 C_2 |w'|_{W^{1,2}(K')};$$

we remark again (see proof of Theorem 1) that \widehat{K}' is star-shaped with respect to any inner point $x \in T'$ and that $T' \subset \widehat{K}' \subset R$.

Hence (6.19) and (6.20) yield

$$\|(w' - L^{(p)}w') v\|_{L_2(\tau_{i,p})} \leq C_{12} p^{-1/2} |w'|_{W^{1,2}(K')},$$

where $C_{12} = C_{11}C_0C_2$, and finally

$$(6.21) \quad \|(w' - L^{(p)}w') v\|_{L_2(T)} \leq C_{12} p^{-1/2} |w'|_{W^{1,2}(\Omega')}.$$

(b) By means similar to those used in the proof of (6.18) we can show that

$$(6.22) \quad \|(L^{(p)}w')(L^{(p)}v) - L^{(p)}(w' \cdot v)\|_{L_2(\tau_{i,p})} \leq C_{13}p^{-1/2}\|\hat{w}'\|_{W^{1,2}(K')},$$

where the constant C_{13} does not depend on p, i, w . If \hat{w}' is constant on \hat{K}' then w' is constant on $\tau_{i,p}$ and hence $(L^{(p)}w')(L^{(p)}v) - L^{(p)}(w' \cdot v) = 0$. It means that we can replace the estimate (6.22) by

$$(6.23) \quad \|(L^{(p)}w')(L^{(p)}v) - L^{(p)}(w' \cdot v)\|_{L_2(\tau_{i,p})} \leq C_{13}p^{-1/2}\|\hat{w}' + \chi\|_{W^{1,2}(K')}$$

for any $\chi = \text{constant}$. Making use of Lemmas 6.1 and 6.2, we estimate

$$\|(L^{(p)}w')(L^{(p)}v) - L^{(p)}(w' \cdot v)\|_{L_2(\tau_{i,p})} \leq C_{14}p^{-1/2}|w'|_{W^{1,2}(K')},$$

i.e.

$$(6.24) \quad \|(L^{(p)}w')(L^{(p)}v) - L^{(p)}(w' \cdot v)\|_{L_2(\Gamma)} \leq C_{14}p^{-1/2}|w'|_{W^{1,2}(\Omega')}.$$

(c) It holds

$$(6.25) \quad \|(L^{(p)}w')(v - L^{(p)}v)\|_{L_2(\Gamma)} \leq \|L^{(p)}w'\|_{L_2(\Gamma)} \|v - L^{(p)}v\|_{L_\infty(\Gamma)}.$$

Since we assume that Γ is infinitely differentiable, we can easily check that

$$(6.26) \quad \|v - L^{(p)}v\|_{L_\infty(\Gamma)} \leq C_{15}p^{-1},$$

where the constant C_{15} is independent of p . We remark that $L^{(p)}v$ is the piecewise linear interpolation of v with respect to a variable which is a parameter of the variety Γ . As v and Γ are smooth enough, the result (6.26) is the same as that in the one-dimensional case.

Lemmas 6.3 and 6.1 yield

$$(6.27) \quad \begin{aligned} \|L^{(p)}w'\|_{L_2(\tau_{i,p})} &\leq C_7p^{-1/2}\|\widehat{L^{(p)}w'}\|_{L_2(\tau_{i,p})} \leq \\ &\leq C_7C_{16}p^{-1/2}\|\hat{w}'\|_{W^{1,2}(\Gamma')} \leq C_7C_{16}p^{-1/2}\|\hat{w}'\|_{W^{1,2}(K')} \leq C_7C_{16}C_2p^{1/2}\|w'\|_{W^{1,2}(K')}, \end{aligned}$$

where the constant C_{16} does not depend on p, i, w .

Setting $C_{17} = C_2C_7C_{15}C_{16}$ we derive from (6.25)–(6.27) that

$$(6.28) \quad \|(L^{(p)}w')(v - L^{(p)}v)\|_{L_2(\Gamma)} \leq C_{17}p^{-1/2}\|w'\|_{W^{1,2}(\Omega')}.$$

(d) The assertion (6.14) follows from (6.21), (6.24) and (6.28)

Theorem 6.2. *If a family $\Omega^{(p)}$ is regular (see Definition 6.4) then the assumption (A2) from Chapter 4 is satisfied.*

Proof. If $w \in V^{(p)}$ then it holds

$$(6.29) \quad \begin{aligned} [w]_v - L^{(p)}[w]_v &= (w'_1v_1 - L^{(p)}(w'_1v_1)) + (w'_2v_2 - L^{(p)}(w'_2v_2)) - \\ &- (w''_1v_1 - L^{(p)}(w''_1v_1)) - (w''_2v_2 - L^{(p)}(w''_2v_2)). \end{aligned}$$

Using Lemma 6.4, we derive from (6.29) that the following estimate holds:

$$(6.30) \quad \|[w]_v - L^{(p)}[w]_v\|_{L_2(r)} \leq C_8 p^{-1/2} \|w\|$$

\forall integer p , $\forall w \in V^{(p)}$. It means that the assumption (A2) is satisfied.

APPENDIX

The aim of this section is the proof of Bramble-Hilbert lemma under the assumption that the domain of independent variables can be varied in a certain sense (see Lemma A.3). Throughout this appendix we assume G_1, G_2 to be bounded simply connected subdomains of the plane such that $\bar{G}_1 \subset G_2$; the restriction on \mathbb{R}_2 is made just for the sake of simplicity. Let P be a fixed point of G_1 . We introduce a family \mathfrak{M} of subdomains G as follows:

$\mathfrak{M} \equiv \{G \text{ is a subdomain in } \mathbb{R}_2; G_1 \subset G \subset G_2, G \text{ has Lipschitz continuous boundary } \partial G, \partial G \text{ is star-shaped with respect to the point } P\}$.

To characterize the family \mathfrak{M} , we fix two balls B_1 and B_2 centered at P , $B_1 \subset \bar{G}_1 \subset G_2 \subset B_2$; let R_1 and R_2 be the radii of B_1 and B_2 . We set $k \equiv R_1/R_2$.

Lemma A.1. *There exists a constant C_1 such that*

$$(A.1) \quad \|u\|_{L_2(G)} \leq C_1 \left(|u|_{W^{1,2}(G)} + \left| \int_G u \, dx \right| \right)$$

for each $G \in \mathfrak{M}$, $u \in W^{1,2}(G)$.

Proof. For a given $G \in \mathfrak{M}$ the class $C^1(\bar{G})$ is dense in $W^{1,2}(G)$. Thus it is sufficient to verify (A.1) assuming $u \in C^1(\bar{G})$ instead of $u \in W^{1,2}(G)$.

We introduce a polar coordinate system $[r, \varphi]$ centered at P . For any domain G there exists a Lipschitz continuous function $r = r(\varphi)$ such that $[r, \varphi] \in \partial G$ iff $r = r(\varphi)$ and $0 \leq \varphi < 2\pi$. If $x \equiv [r_1, \varphi_1]$ and $y \equiv [r_2, \varphi_2]$ belong to G then $u(x) - u(y) = \alpha_1 + \alpha_2 + \alpha_3$, where

$$\begin{aligned} \alpha_1 &= \alpha_1(r_1, \varphi_1) = u(r_1, \varphi_1) - u(kr_1, \varphi_1), \\ \alpha_2 &= \alpha_2(r_1, \varphi_1, \varphi_2) = u(kr_1, \varphi_1) - u(kr_1, \varphi_2), \\ \alpha_3 &= \alpha_3(r_1, r_2, \varphi_2) = u(kr_1, \varphi_2) - u(r_2, \varphi_2). \end{aligned}$$

Let us note that $[r, \varphi] \in G$ implies $[kr, \varphi] \in B_1$. Assuming $u \in C^1(\bar{G})$, we can write

$$\begin{aligned} \alpha_1 &= \int_{kr_1}^{r_1} \frac{\partial u}{\partial r}(r, \varphi_1) \, dr; \quad \alpha_2 = \int_{\varphi_2}^{\varphi_1} \frac{\partial u}{\partial \varphi}(kr_1, \varphi) \, d\varphi; \\ \alpha_3 &= \int_{kr_1}^{r_2} \frac{\partial u}{\partial r}(r, \varphi_2) \, dr \end{aligned}$$

and using the Hölder inequality we estimate

$$(A.2) \quad \begin{aligned} \alpha_1^2 &\leq \left| \log \frac{1}{k} \right| \int_0^{r(\varphi_1)} r \left| \frac{\partial u}{\partial r}(r, \varphi_1) \right|^2 dr, \\ \alpha_2^2 &\leq 2\pi \int_0^{2\pi} \left| \frac{\partial u}{\partial \varphi}(kr_1, \varphi) \right|^2 d\varphi, \\ \alpha_3^2 &\leq \left| \log \frac{1}{k} \right| \int_0^{r(\varphi_2)} r \left| \frac{\partial u}{\partial r}(r, \varphi_2) \right|^2 dr. \end{aligned}$$

Since

$$\begin{aligned} |u(x) - u(y)|^2 &= |u(x)|^2 + |u(y)|^2 - 2u(x)u(y) \leq \\ &\leq 3(\alpha_1^2 + \alpha_2^2 + \alpha_3^2), \end{aligned}$$

we obtain by double integration over G that

$$\begin{aligned} &2(\text{meas } G) \|u\|_{L_2(G)}^2 - 2 \left(\int_G u(x) dx \right)^2 \leq \\ &\leq 3 \int_0^{2\pi} \int_0^{2\pi} \int_0^{r(\varphi_1)} \int_0^{r(\varphi_2)} r_1 r_2 (\alpha_1^2 + \alpha_2^2 + \alpha_3^2) dr_2 dr_1 d\varphi_1, d\varphi_2. \end{aligned}$$

Using the bounds (A.2) one can easily conclude that there exists a constant C_2 (independent of u and G) such that the right hand side of the above inequality can be bounded by

$$C_2 \int_0^{2\pi} \int_0^{r(\varphi)} \left(r \left| \frac{\partial u}{\partial r} \right|^2 + \frac{1}{r} \left| \frac{\partial u}{\partial \varphi} \right|^2 \right) dr d\varphi$$

which is equal to $C_2 |u|_{W^{1,2}(G)}^2$ in Cartesian coordinates. We immediately get (A.1) with $C_1 = (\text{meas } G_1)^{1/2} \max(1, (2^{-1}C_2)^{1/2})$.

Lemma A.2. *There exists a constant C_3 satisfying*

$$(A.3) \quad \inf_{c=\text{const.}} \|u + c\|_{W^{1,2}(G)} \leq C_3 |u|_{W^{1,2}(G)}$$

for each $G \in \mathfrak{M}$, $u \in W^{1,2}(G)$.

Proof. The inequality (A.3) follows directly from (A.1).

Lemma A.3. *For any integer k there exists a constant K_k such that*

$$(A.4) \quad \inf_{\chi \in P_{k-1}} \|u + \chi\|_{W^{k,2}(G)} \leq K_k |u|_{W^{k,2}(G)}$$

for each $G \in \mathfrak{M}$, $u \in W^{k,2}(G)$; P_n denotes the set of all polynomials of the n -th degree.

Proof. According to Lemma A.2 the inequality (A.4) holds for $k = 1$. Assume (A.4) to be valid for a given integer $k = n - 1$. Note that $\chi_{n-1} \in P_{n-1}$ iff

$$\chi_{n-1} = \chi_{n-2} + \sum_{|\alpha|=n-1} a_\alpha x_1^{\alpha_1} x_2^{\alpha_2},$$

where α_i is an integer, $|\alpha| \equiv \alpha_1 + \alpha_2$ and a_α are constants.

First we realize that

$$\inf_{\chi \in P_{n-1}} \|u + \chi\|_{W^{n,2}(G)} = \left(\inf_{\chi \in P_{n-1}} \|u + \chi\|_{W^{n-1,2}(G)}^2 + |u|_{W^{n,2}(G)}^2 \right)^{1/2}$$

and estimate

$$\begin{aligned} \inf_{\chi \in P_{n-1}} \|u + \chi\|_{W^{n-1,2}(G)}^2 &\leq \inf_{\{a_\alpha\}_{|\alpha|=n-1}} \inf_{\chi_0 \in P_{n-2}} \|u + \sum_{|\alpha|=n-1} a_\alpha x_1^{\alpha_1} x_2^{\alpha_2} + \chi_0\|_{W^{n-1,2}(G)}^2 \leq \\ &\leq K_{n-1}^2 \inf_{\{a_\alpha\}_{|\alpha|=n-1}} \|u + \sum_{|\alpha|=n-1} a_\alpha x_1^{\alpha_1} x_2^{\alpha_2}\|_{W^{n-1,2}(G)}^2, \end{aligned}$$

where the last inequality follows from the induction assumption. According to Lemma A.2 we further estimate

$$\begin{aligned} &\inf_{\{a_\alpha\}_{|\alpha|=n-1}} \|u + \sum_{|\alpha|=n-1} a_\alpha x_1^{\alpha_1} x_2^{\alpha_2}\|_{W^{n-1,2}(G)}^2 \leq \\ &\leq \sum_{\alpha=n-1} \inf_{a_\alpha = \text{const.}} \|D^\alpha u + a_\alpha\|_{L_2(G)}^2 \leq K_1^2 \sum_{|\alpha|=n-1} \|D^\alpha u\|_{W^{1,2}(G)}^2 \leq K_1^2 |u|_{W^{n,2}(G)}^2. \end{aligned}$$

Thus we finally conclude that

$$\inf_{\chi \in P_{n-1}} \|u + \chi\|_{W^{n,2}(G)} \leq (1 + K_1^2 K_{n-1}^2)^{1/2} |u|_{W^{n,2}(G)}$$

which completes the n -th induction step with $K_n = (1 + K_1^2 K_{n-1}^2)^{1/2}$ obviously K_n is independent of the choice of u and G .

References

- [1] *J. H. Bramble, S. Hilbert*: Bounds for a class of linear functionals with applications to Hermite interpolation, *Numer. Math.*, 16, 1971, 362—369.
- [2] *P. K. Ciarlet, P. A. Raviart*: General Lagrange and Hermite interpolation in R_m with application to finite element methods, *Arch. Rat. Mech. Anal.* 46, 1972, 172—199.
- [3] *V. Janovský*: Contact problem of two elastic bodies, Technical Report BICOM 77-2, Institute of Computational Math., Brunel Univ., England.
- [4] *V. Janovský, P. Procházka*: Contact problem of two elastic bodies-Part I, *Aplikace matematiky* 25 (1980), 87—109.
- [5] *A. Kufner, O. John, S. Fučík*: *Function Spaces*, Academia, Prague 1977.
- [6] *J. Nečas*: *Les Méthodes directes en théorie des équations elliptiques*, Mason, Paris, 1967.

Authors' addresses: Dr. *Vladimír Janovský*, CSc., MFF UK, Malostranské nám. 25, 118 00 Praha 1; Dr. Ing. *Petr Procházka*, CSc., PÚ VHMP, Žitná 49, 110 00 Praha 1.